

有关敝公司产品的注意事项

请务必在使用敝公司产品之前阅读。



注意

产品目录中的记载内容

本产品目录中所记载的内容为2019年10月的内容。因产品改良等原因，可能会不经预告而变更其记载内容，或是停止供应本产品目录中所记载的产品。所以，请务必在使用前先确认最新的产品信息。

未按照本产品目录中所记载的内容或交货规格说明书使用敝公司产品，即便其致使用设备发生损害、不良情况等时，敝公司也不承担任何责任，敬请知悉。

签署交货规格说明书

就本产品目录中所记载产品的产品规格等相关内容，敝公司备有交货规格说明书，详情请向敝公司咨询。在使用敝公司产品前请务必就交货规格说明书之内容确认并批准之。

实装前的事前评估

使用敝公司产品时，请务必事先安装到使用设备之后，在实际使用的环境下进行评估和确认。

用途的限定

1. 可以使用的设备

本产品目录中所记载的产品预设为使用于一般电子设备 [音像设备、办公自动化设备、家电产品、办公设备、信息通讯设备 (手机、电脑等)] 以及面向本产品目录或是交货规格说明书中另行注明的设备通用性、标准性用途。

另外，面向汽车用电子设备、电信基础设施 / 工业设备、医疗设备 (国际 (GHTF) 第一类、第二类、第三类) 方面的应用，敝公司也备有预设的产品线，请参考本产品目录或是交货规格说明书的内容，使用相对应的产品。

2. 需要另行确认的设备

若考虑将本产品目录中所记载的产品使用于当产品发生故障、品质不良，或是由此引起的运转失常而可能会危及生命、身体或是财产，以及有可能给社会造成深刻影响的以下设备 (不包括本产品目录或是交货规格说明书中另行注明可以使用设备) 等时，请务必事先向敝公司咨询。

- (1) 运输用设备 (汽车驱动控制设备、火车控制设备、船舶控制设备等)
- (2) 交通信号设备
- (3) 防灾 / 保安设备
- (4) 医疗设备 (国际 (GHTF) 第二类)
- (5) 高公共性信息通讯设备 / 信息处理设备 (电话交换机、电话 / 无线 / 广播电视基站等)
- (6) 其他与上述设备有同等品质与可靠性要求的设备

3. 禁止使用的设备

请勿将敝公司产品使用于对安全性和可靠性有着极高要求的以下设备。

- (1) 航天设备 (人工卫星、火箭等)
- (2) 航空设备^(注释1)
- (3) 医疗设备 (国际 (GHTF) 第四类)、植体 (体内植入型) 医疗设备^(注释2)
- (4) 发电控制设备 (面向核能 / 水力 / 火力发电厂等的设备)
- (5) 海底设备 (海底中继设备、海中的作业设备等)
- (6) 军事设备
- (7) 其他与上述设备有同等品质与可靠性要求的设备

注释 1：仅限于对航空设备的安全运行不产生直接干扰的设备 [机内娱乐设备、机内照明设备、电动座椅、餐饮设备等]，在满足敝公司另行指定的相关条件时，亦可将敝公司产品用于以上用途。在贵公司考虑将敝公司的产品用于以上用途时，请务必事先向敝公司咨询相关的信息。

注释 2：包括注入人体内的部分和与此相连接的体外部分。

4. 责任的限制

未经敝公司的事先书面同意，把本产品目录中所记载的产品使用于非敝公司预设用途的设备、前述需要向敝公司咨询的设备或敝公司禁止使用的设备，从而给客户或第三方造成损害的，敝公司不承担任何责任，敬请知悉。

安全设计

需将敝公司的产品使用于对安全性和可靠性要求较高的设备、电路上时，请进行充分的安全性评估和可靠性评估。另外，请通过设置保护电路、保护装置的系统，设置冗余电路不会被单一故障影响安全性的系统等失效导向安全 (fail-safe) 设计，确保充分的安全性。

有关知识产权

本产品目录中所记载的信息是用于说明相关产品的典型操作以及相关应用。此类信息的使用不代表对于敝公司以及第三方的知识产权以及其他权利的使用许可或是不侵权保证。

保证范围

敝公司产品的保证范围仅限于已经交付的敝公司产品本身，由敝公司产品的故障或不良情况所诱发的损害，敝公司不承担任何责任，敬请知悉。但是，以书面形式另行签署了交易基本合同书、品质保证协定书等时，敝公司将根据该合同的条件提供保证。

正规销售渠道

本产品目录中所记载的内容适用于从敝公司营业所、销售子公司、销售代理店 (即“正规销售渠道”) 购买的敝公司产品，并不适用于从其他渠道购买的敝公司产品，敬请知悉。

出口时的注意事项

本产品目录中所记载的部分产品在出口时须事先确认《外汇和对外贸易法》以及美国在出口管理方面的相关法规，并办理相关手续。如有不明之处，请向敝公司咨询。

金属磁芯绕线型片状功率电感器 (MCOIL™ MA 系列)



回流焊

■ 型号标示法

※使用温度范围: -40~+105°C (包含产品本身发热)

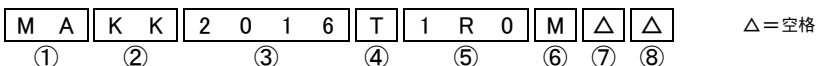

① 类型

| 代码 | 类型 |
|----|----------------|
| MA | 金属磁芯绕线型片状功率电感器 |

② 尺寸 (T)

| 代码 | 尺寸 (T) [mm] |
|----|-------------|
| KK | 1.0 |
| MK | 1.2 |

③ 尺寸 (L×W)

| 代码 | 外型 (inch) | 尺寸 (L×W) [mm] |
|------|------------|---------------|
| 2016 | 2016(0806) | 2.0 × 1.6 |
| 2520 | 2520(1008) | 2.5 × 2.0 |

④ 包装

| 代码 | 包装 |
|----|------|
| T | 卷盘带装 |

⑤ 标称电感值

| 代码 (例) | 标称电感值 [μH] |
|--------|------------|
| R47 | 0.47 |
| 1R0 | 1.0 |
| 4R7 | 4.7 |

※R = 小数点

⑥ 电感量公差

| 代码 | 电感量公差 |
|----|-------|
| M | ±20% |

⑦ 个别规格

| 代码 | 个别规格 |
|----|------|
| △ | 标准品 |

⑧ 本公司管理记号

■ 标准外型尺寸 / 标准数量

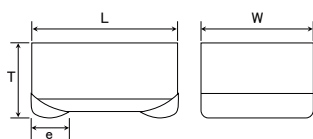

推荐焊盘图案

实装上的注意

- 请确认实装状态后使用。
- 本产品焊法限定为回流焊法。

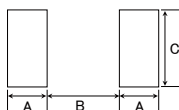

| Type | A | B | C |
|------|-----|-----|-----|
| 2016 | 0.7 | 0.8 | 1.8 |
| 2520 | 0.8 | 1.2 | 2.0 |

单位: mm

| Type | L | W | T | e | 标准数量 [pcs] 卷盘带装 |
|----------|------------------------------|------------------------------|------------------------|------------------------------|--------------------|
| MAKK2016 | 2.0 ± 0.1 (0.079 ± 0.004) | 1.6 ± 0.1 (0.063 ± 0.004) | 1.0 max (0.039 max) | 0.5 ± 0.3 (0.020 ± 0.012) | 3000 |
| MAKK2520 | 2.5 ± 0.2 (0.098 ± 0.008) | 2.0 ± 0.2 (0.079 ± 0.008) | 1.0 max (0.039 max) | 0.5 ± 0.3 (0.020 ± 0.012) | 3000 |
| MAMK2520 | 2.5 ± 0.2 (0.098 ± 0.008) | 2.0 ± 0.2 (0.079 ± 0.008) | 1.2 max (0.047 max) | 0.5 ± 0.3 (0.020 ± 0.012) | 3000 |

单位: mm (inch)

▶ 由于篇幅有限, 本产品目录中只记载了有代表性的产品规格, 若考虑使用敝公司产品时, 请确认交货规格说明书中的详细规格。另外, 有关各产品的详细信息(特性图、可靠性信息、使用时的注意事项等), 请参阅敝公司网站 (<http://www.ty-top.com/>)。

■ 型号一览

● MAKK2016(0806) 型 【厚度:1.0mm max.】

| 型号 | EHS | 标称电感值 [μH] | 电感量公差 | 自共振频率 [MHz] (min.) | 直流电阻 [Ω] (max.) | 额定电流 ※) [mA] (max.) | | 测试频率 [MHz] |
|---------------|------|---------------|-------|-----------------------|--------------------|---------------------|------------------|---------------|
| | | | | | | 直流重叠允许电流 Idc1 | 温度上升允许电流 Idc2 | |
| MAKK2016TR24M | RoHS | 0.24 | ±20% | - | 0.037 | 4,200 | 3,000 | 2 |
| MAKK2016TR33M | RoHS | 0.33 | ±20% | - | 0.040 | 3,600 | 3,200 | 2 |
| MAKK2016TR47M | RoHS | 0.47 | ±20% | - | 0.460 | 3,200 | 2,800 | 2 |
| MAKK2016TR68M | RoHS | 0.68 | ±20% | - | 0.065 | 2,500 | 2,500 | 2 |
| MAKK2016T1R0M | RoHS | 1.0 | ±20% | - | 0.075 | 2,200 | 2,200 | 2 |
| MAKK2016T1R5M | RoHS | 1.5 | ±20% | - | 0.130 | 1,600 | 1,650 | 2 |
| MAKK2016T2R2M | RoHS | 2.2 | ±20% | - | 0.160 | 1,500 | 1,500 | 2 |
| MAKK2016T3R3M | RoHS | 3.3 | ±20% | - | 0.255 | 1,150 | 1,200 | 2 |
| MAKK2016T4R7M | RoHS | 4.7 | ±20% | - | 0.380 | 1,000 | 950 | 2 |

● MAKK2520(1008) 型 【厚度:1.0mm max.】

| 型号 | EHS | 标称电感值 [μH] | 电感量公差 | 自共振频率 [MHz] (min.) | 直流电阻 [Ω] (max.) | 额定电流 ※) [mA] (max.) | | 测试频率 [MHz] |
|---------------|------|---------------|-------|-----------------------|--------------------|---------------------|------------------|---------------|
| | | | | | | 直流重叠允许电流 Idc1 | 温度上升允许电流 Idc2 | |
| MAKK2520TR33M | RoHS | 0.33 | ±20% | - | 0.038 | 4,700 | 3,500 | 2 |
| MAKK2520TR47M | RoHS | 0.47 | ±20% | - | 0.046 | 3,900 | 3,200 | 2 |
| MAKK2520TR68M | RoHS | 0.68 | ±20% | - | 0.059 | 3,700 | 2,900 | 2 |
| MAKK2520T1R0M | RoHS | 1.0 | ±20% | - | 0.072 | 2,700 | 2,500 | 2 |
| MAKK2520T1R5M | RoHS | 1.5 | ±20% | - | 0.125 | 2,300 | 1,800 | 2 |
| MAKK2520T2R2M | RoHS | 2.2 | ±20% | - | 0.156 | 1,900 | 1,500 | 2 |
| MAKK2520T3R3M | RoHS | 3.3 | ±20% | - | 0.200 | 1,550 | 1,300 | 2 |
| MAKK2520T4R7M | RoHS | 4.7 | ±20% | - | 0.300 | 1,300 | 1,100 | 2 |

● MAMK2520(1008) 型 【厚度:1.2mm max.】

| 型号 | EHS | 标称电感值 [μH] | 电感量公差 | 自共振频率 [MHz] (min.) | 直流电阻 [Ω] (max.) | 额定电流 ※) [mA] (max.) | | 测试频率 [MHz] |
|---------------|------|---------------|-------|-----------------------|--------------------|---------------------|------------------|---------------|
| | | | | | | 直流重叠允许电流 Idc1 | 温度上升允许电流 Idc2 | |
| MAMK2520TR47M | RoHS | 0.47 | ±20% | - | 0.039 | 4,200 | 3,400 | 2 |
| MAMK2520TR68M | RoHS | 0.68 | ±20% | - | 0.048 | 3,200 | 3,200 | 2 |
| MAMK2520T1R0M | RoHS | 1.0 | ±20% | - | 0.059 | 3,100 | 2,700 | 2 |
| MAMK2520T2R2M | RoHS | 2.2 | ±20% | - | 0.110 | 2,000 | 1,900 | 2 |
| MAMK2520T3R3M | RoHS | 3.3 | ±20% | - | 0.156 | 1,800 | 1,700 | 2 |
| MAMK2520T4R7M | RoHS | 4.7 | ±20% | - | 0.260 | 1,500 | 1,300 | 2 |

※) 直流重叠允许电流 (Idc1) 为直流重叠带来的电感值下降, 范围在30%以内的直流电感值 (at 20°C)

※) 温度上升允许电流 (Idc2) 为温度上升到40°C时的直流电感值 (at 20°C)

※) 额定电流值为Idc1 或 Idc2 中较低的直流电流值。

METAL CORE WIRE-WOUND CHIP POWER INDUCTORS (MCOIL™ MA SERIES / MCOIL™ MA-H SERIES)

PACKAGING

① Minimum Quantity

| Type | Standard Quantity [pcs] |
|----------|-------------------------|
| | Tape & Reel |
| MAKK2016 | 3000 |
| MAKK2520 | 3000 |
| MAMK2520 | 3000 |

② Tape Material

● Embossed Tape

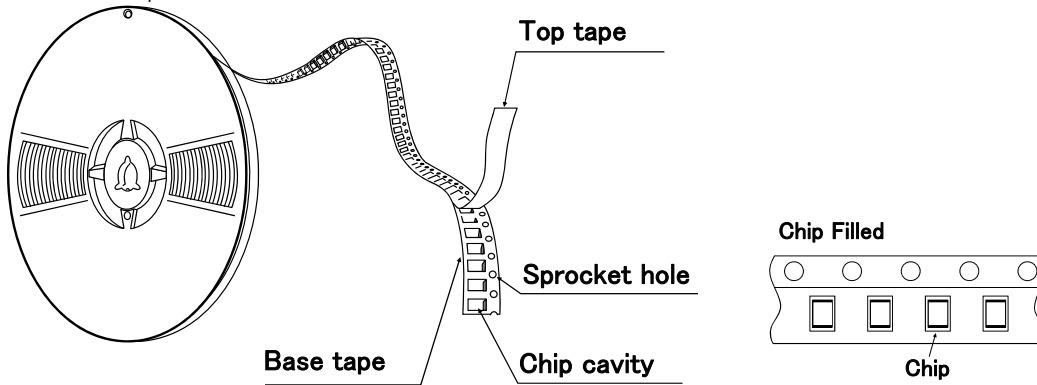

③ Taping dimensions

● Embossed tape 8mm wide (0.315 inches wide)

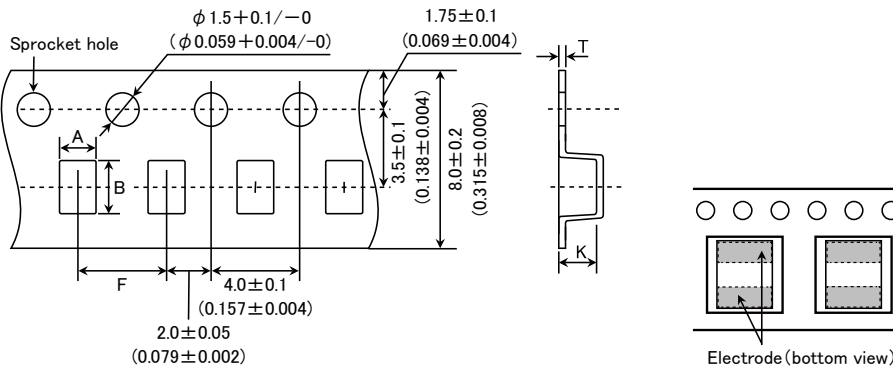

| Type | Chip cavity | | Insertion pitch | Tape thickness | |
|----------|--|--|--|--|-------------------------|
| | A | B | F | T | K |
| MAKK2016 | 1.9 ± 0.1 (0.075 ± 0.004) | 2.3 ± 0.1 (0.091 ± 0.004) | 4.0 ± 0.1 (0.157 ± 0.004) | 0.25 ± 0.05 (0.009 ± 0.002) | 1.2 max (0.047 max) |
| MAKK2520 | 2.3 ± 0.1 (0.091 ± 0.004) | 2.8 ± 0.1 (0.110 ± 0.004) | 4.0 ± 0.1 (0.157 ± 0.004) | 0.3 ± 0.05 (0.012 ± 0.002) | 1.25 max (0.049 max) |
| MAMK2520 | 2.3 ± 0.1 (0.091 ± 0.004) | 2.8 ± 0.1 (0.110 ± 0.004) | 4.0 ± 0.1 (0.157 ± 0.004) | 0.3 ± 0.05 (0.012 ± 0.002) | 1.4 max (0.055 max) |

Unit: mm (inch)

④ Leader and Blank portion

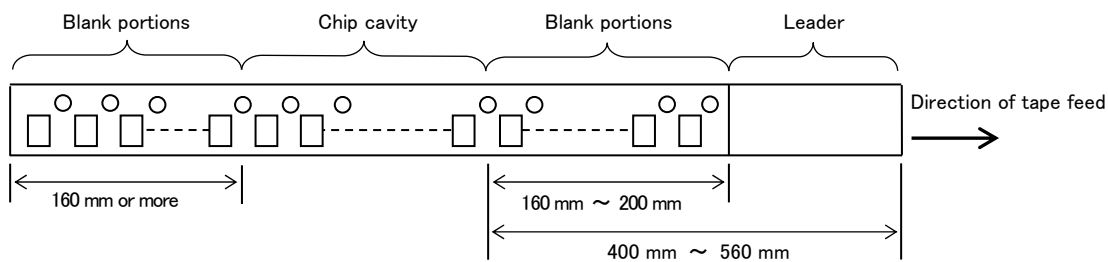

▶ This catalog contains the typical specification only due to the limitation of space. When you consider the purchase of our products, please check our specification. For details of each product (characteristics graph, reliability information, precautions for use, and so on), see our Web site (<http://www.ty-top.com/>).

⑤ Reel size



| Type | Reel size (Reference values) | | |
|----------|------------------------------|----------------|---------------|
| | ϕD | ϕd | W |
| MAKK2016 | 180+0/-3 | 60+1/-0 | 10.0±1.5 |
| MAKK2520 | (7.087+0/-0.118) | (2.36+0.039/0) | (0.394±0.059) |
| MAMK2520 | | | |

Unit: mm (inch)

⑥ Top Tape Strength

The top The top tape requires a peel-off force of 0.1 to 1.2N in the direction of the arrow as illustrated below.



METAL CORE WIRE-WOUND CHIP POWER INDUCTORS (MCOIL™ MA SERIES / MCOIL™ MA-H SERIES)

RELIABILITY DATA

| 1. Operating Temperature Range | | |
|---------------------------------------|---|---------------------------------------|
| Specified Value | MA series | -40~+105°C |
| | MA-H series | -40~+125°C |
| Test Methods and Remarks | Including self-generated heat | |
| 2. Storage Temperature Range | | |
| Specified Value | MA series | -40~+85°C |
| | MA-H series | |
| Test Methods and Remarks | 0 to 40°C for the product with taping. | |
| 3. Rated current | | |
| Specified Value | MA series | Within the specified tolerance |
| | MA-H series | |
| 4. Inductance | | |
| Specified Value | MA series | Within the specified tolerance |
| | MA-H series | |
| Test Methods and Remarks | Measuring equipment : LCR Meter (HP 4285A or equivalent) Measuring frequency : 2MHz, 1V | |
| 5. DC Resistance | | |
| Specified Value | MA series | Within the specified tolerance |
| | MA-H series | |
| Test Methods and Remarks | Measuring equipment : DC ohmmeter (HIOKI 3227 or equivalent) | |
| 6. Self resonance frequency | | |
| Specified Value | MA series | - |
| | MA-H series | |
| 7. Temperature characteristic | | |
| Specified Value | MA series | Inductance change : Within $\pm 15\%$ |
| | MA-H series | |
| Test Methods and Remarks | Measurement of inductance shall be taken at temperature range within -40°C~+85°C. With reference to inductance value at +20°C., change rate shall be calculated. | |
| 8. Resistance to flexure of substrate | | |
| Specified Value | MA series | No damage |
| | MA-H series | |
| Test Methods and Remarks | <p>The test samples shall be soldered to the test board by the reflow. As illustrated below, apply force in the direction of the arrow indicating until deflection of the test board reaches to 2 mm.</p> <p>Test board size : 100 × 40 × 1.0 mm Test board material : Glass epoxy-resin Solder cream thickness : 0.12 mm</p> | |

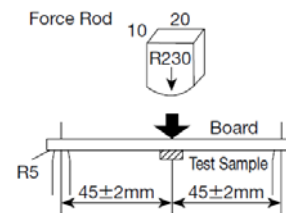

▶ This catalog contains the typical specification only due to the limitation of space. When you consider the purchase of our products, please check our specification.
 For details of each product (characteristics graph, reliability information, precautions for use, and so on), see our Web site (<http://www.ty-top.com/>).

| 9. Insulation resistance : between wires | | | | | | | | | | | | | |
|---|---|--|--------------------|--------------------------|-----------------|--|-----------------|--------------------------------|------|---|---------------------------------------|---|---|
| Specified Value | MA series | — | | | | | | | | | | | |
| | MA-H series | | | | | | | | | | | | |
| 10. Insulation resistance : between wire and core | | | | | | | | | | | | | |
| Specified Value | MA series | — | | | | | | | | | | | |
| | MA-H series | | | | | | | | | | | | |
| 11. Withstanding voltage : between wire and core | | | | | | | | | | | | | |
| Specified Value | MA series | — | | | | | | | | | | | |
| | MA-H series | | | | | | | | | | | | |
| 12. Adhesion of terminal electrode | | | | | | | | | | | | | |
| Specified Value | MA series | No abnormality. | | | | | | | | | | | |
| | MA-H series | | | | | | | | | | | | |
| Test Methods and Remarks | <p>The test samples shall be soldered to the test board by the reflow.</p> <p>Applied force : 10N to X and Y directions.</p> <p>Duration : 5s.</p> <p>Solder cream thickness : 0.12mm.</p> | | | | | | | | | | | | |
| 13. Resistance to vibration | | | | | | | | | | | | | |
| Specified Value | MA series | Inductance change : Within $\pm 10\%$ No significant abnormality in appearance. | | | | | | | | | | | |
| | MA-H series | | | | | | | | | | | | |
| Test Methods and Remarks | <p>The test samples shall be soldered to the test board by the reflow.</p> <p>Then it shall be submitted to below test conditions.</p> <table border="1"> <tr> <td>Frequency Range</td> <td>10~55Hz</td> </tr> <tr> <td>Total Amplitude</td> <td>1.5mm (May not exceed acceleration 196m/s²)</td> </tr> <tr> <td>Sweeping Method</td> <td>10Hz to 55Hz to 10Hz for 1min.</td> </tr> <tr> <td rowspan="3">Time</td> <td>X</td> <td rowspan="3">For 2 hours on each X, Y, and Z axis.</td> </tr> <tr> <td>Y</td> </tr> <tr> <td>Z</td> </tr> </table> <p>Recovery : At least 2hrs of recovery under the standard condition after the test, followed by the measurement within 48hrs.</p> | | Frequency Range | 10~55Hz | Total Amplitude | 1.5mm (May not exceed acceleration 196m/s ²) | Sweeping Method | 10Hz to 55Hz to 10Hz for 1min. | Time | X | For 2 hours on each X, Y, and Z axis. | Y | Z |
| | Frequency Range | 10~55Hz | | | | | | | | | | | |
| Total Amplitude | 1.5mm (May not exceed acceleration 196m/s ²) | | | | | | | | | | | | |
| Sweeping Method | 10Hz to 55Hz to 10Hz for 1min. | | | | | | | | | | | | |
| Time | X | For 2 hours on each X, Y, and Z axis. | | | | | | | | | | | |
| | Y | | | | | | | | | | | | |
| | Z | | | | | | | | | | | | |
| | | | | | | | | | | | | | |
| 14. Solderability | | | | | | | | | | | | | |
| Specified Value | MA series | At least 90% of surface of terminal electrode is covered by new solder. | | | | | | | | | | | |
| | MA-H series | | | | | | | | | | | | |
| Test Methods and Remarks | <p>The test samples shall be dipped in flux, and then immersed in molten solder as shown in below table.</p> <p>Flux : Methanol solution containing rosin 25%.</p> <table border="1"> <tr> <td>Solder Temperature</td> <td>245\pm5$^{\circ}$C</td> </tr> <tr> <td>Time</td> <td>5\pm0.5 sec.</td> </tr> </table> <p>※Immersion depth : All sides of mounting terminal shall be immersed.</p> | | Solder Temperature | 245 \pm 5 $^{\circ}$ C | Time | 5 \pm 0.5 sec. | | | | | | | |
| Solder Temperature | 245 \pm 5 $^{\circ}$ C | | | | | | | | | | | | |
| Time | 5 \pm 0.5 sec. | | | | | | | | | | | | |
| 15. Resistance to soldering heat | | | | | | | | | | | | | |
| Specified Value | MA series | Inductance change : Within $\pm 10\%$ No significant abnormality in appearance. | | | | | | | | | | | |
| | MA-H series | | | | | | | | | | | | |
| Test Methods and Remarks | <p>The test sample shall be exposed to reflow oven at 230$^{\circ}$C for 40 seconds, with peak temperature at 260+0/-5$^{\circ}$C for 5 seconds, 3 times.</p> <p>Test board material : Glass epoxy-resin</p> <p>Test board thickness : 1.0mm</p> <p>Recovery : At least 2hrs of recovery under the standard condition after the test, followed by the measurement within 48hrs.</p> | | | | | | | | | | | | |

| 16. Thermal shock | | |
|---|---|--|
| Specified Value | MA series | Inductance change : Within $\pm 10\%$ No significant abnormality in appearance. |
| | MA-H series | |
| Test Methods and Remarks | The test samples shall be soldered to the test board by the reflow. The test samples shall be placed at specified temperature for specified time by step 1 to step 4 as shown in below table in sequence. The temperature cycle shall be repeated 100 cycles. | |
| | Conditions of 1 cycle | |
| | Step | Temperature ($^{\circ}\text{C}$) |
| | 1 | -40 ± 3 |
| | 2 | Room temperature |
| | 3 | $+85 \pm 2$ |
| 4 | Room temperature | |
| Recovery : At least 2hrs of recovery under the standard condition after the test, followed by the measurement within 48hrs. | | Duration (min) |
| | | 30 ± 3 |
| | | Within 3 |
| | | 30 ± 3 |
| | | Within 3 |

| 17. Damp heat | | |
|---|--|--|
| Specified Value | MA series | Inductance change : Within $\pm 10\%$ No significant abnormality in appearance. |
| | MA-H series | |
| Test Methods and Remarks | The test samples shall be soldered to the test board by the reflow. | |
| | The test samples shall be placed in thermostatic oven set at specified temperature and humidity as shown in below table. | |
| | Temperature | $60 \pm 2^{\circ}\text{C}$ |
| | Humidity | $90 \sim 95\% \text{RH}$ |
| | Time | $500 + 24 / - 0$ hour |
| Recovery : At least 2hrs of recovery under the standard condition after the test, followed by the measurement within 48hrs. | | |

| 18. Loading under damp heat | | |
|---|---|--|
| Specified Value | MA series | Inductance change : Within $\pm 10\%$ No significant abnormality in appearance. |
| | MA-H series | |
| Test Methods and Remarks | The test samples shall be soldered to the test board by the reflow. | |
| | The test samples shall be placed in thermostatic oven set at specified temperature and humidity and applied the rated current continuously as shown in below table. | |
| | Temperature | $60 \pm 2^{\circ}\text{C}$ |
| | Humidity | $90 \sim 95\% \text{RH}$ |
| | Applied current | Rated current |
| | Time | $500 + 24 / - 0$ hour |
| Recovery : At least 2hrs of recovery under the standard condition after the test, followed by the measurement within 48hrs. | | |

| 19. Low temperature life test | | |
|-------------------------------|--|--|
| Specified Value | MA series | Inductance change : Within $\pm 10\%$ No significant abnormality in appearance. |
| | MA-H series | |
| Test Methods and Remarks | The test samples shall be soldered to the test board by the reflow. After that, the test samples shall be placed at test conditions as shown in below table. | |
| | Temperature | $-40 \pm 2^{\circ}\text{C}$ |
| | Time | $500 + 24 / - 0$ hour |
| | Recovery : At least 2hrs of recovery under the standard condition after the test, followed by the measurement within 48hrs. | |

| 20. High temperature life test | | |
|--------------------------------|--|--|
| Specified Value | MA series | Inductance change : Within $\pm 10\%$ No significant abnormality in appearance. |
| | MA-H series | |
| Test Methods and Remarks | The test samples shall be soldered to the test board by the reflow. After that, the test samples shall be placed at test conditions as shown in below table. | |
| | Temperature | $85 \pm 2^{\circ}\text{C}$ |
| | Time | $500 + 24 / - 0$ hour |
| | Recovery : At least 2hrs of recovery under the standard condition after the test, followed by the measurement within 48hrs. | |

| 21. Loading at high temperature life test | | |
|---|-------------|---|
| Specified Value | MA series | - |
| | MA-H series | |

22. Standard condition

| | | |
|-----------------|-------------|--|
| Specified Value | MA series | Standard test condition : Unless otherwise specified, temperature is $20 \pm 15^{\circ}\text{C}$ and $65 \pm 20\%$ of relative humidity. When there is any question concerning measurement result: In order to provide correlation data, the test shall be condition of $20 \pm 2^{\circ}\text{C}$ of temperature, $65 \pm 5\%$ relative humidity. Inductance is in accordance with our measured value. |
| | MA-H series | |

METAL CORE WIRE-WOUND CHIP POWER INDUCTORS (MCOIL™ MA SERIES / MCOIL™ MA-H SERIES)

■ PRECAUTIONS

| 1. Circuit Design | |
|---|---|
| Precautions | <p>◆Operating environment</p> <p>1. The products described in this specification are intended for use in general electronic equipment,(office supply equipment, telecommunications systems, measuring equipment, and household equipment). They are not intended for use in mission-critical equipment or systems requiring special quality and high reliability (traffic systems, safety equipment, aerospace systems, nuclear control systems and medical equipment including life-support systems.) where product failure might result in loss of life, injury or damage. For such uses, contact TAIYO YUDEN Sales Department in advance.</p> |
| 2. PCB Design | |
| Precautions | <p>◆Land pattern design</p> <p>1. Please refer to a recommended land pattern.</p> |
| Technical considerations | <p>◆Land pattern design</p> <p>Surface Mounting</p> <ul style="list-style-type: none"> • Mounting and soldering conditions should be checked beforehand. • Applicable soldering process to this products is reflow soldering only. |
| 3. Considerations for automatic placement | |
| Precautions | <p>◆Adjustment of mounting machine</p> <p>1. Excessive impact load should not be imposed on the products when mounting onto the PC boards.</p> <p>2. Mounting and soldering conditions should be checked beforehand.</p> |
| Technical considerations | <p>◆Adjustment of mounting machine</p> <p>1. When installing products, care should be taken not to apply distortion stress as it may deform the products.</p> |
| 4. Soldering | |
| Precautions | <p>◆Reflow soldering</p> <p>1. Please contact any of our offices for a reflow soldering, and refer to the recommended condition specified.</p> <p>2. The product shall be used reflow soldering only.</p> <p>3. Please do not add any stress to a product until it returns in normal temperature after reflow soldering.</p> <p>◆Lead free soldering</p> <p>1. When using products with lead free soldering, we request to use them after confirming adhesion, temperature of resistance to soldering heat, soldering etc sufficiently.</p> |
| Technical considerations | <p>◆Reflow soldering</p> <p>1. If products are used beyond the range of the recommended conditions, heat stresses may deform the products, and consequently degrade the reliability of the products.</p> <p>Recommended reflow condition (Pb free solder)</p> <p>The graph plots Temperature [°C] on the y-axis (0 to 300) against Heating Time [sec] on the x-axis. The profile starts at approximately 80°C, ramps up to a temperature range of 150~180°C. A horizontal dwell of 90±30sec is indicated at this level. The temperature then ramps up to a peak of 260+0/-5°C. A horizontal dwell of 5sec max is shown at the peak. The temperature then ramps down to a minimum of 230°C, where a horizontal dwell of 40sec max is indicated, before finally cooling down.</p> |
| 5. Cleaning | |
| Precautions | <p>◆Cleaning conditions</p> <p>1. Washing by supersonic waves shall be avoided.</p> |
| Technical considerations | <p>◆Cleaning conditions</p> <p>1. If washed by supersonic waves, the products might be broken.</p> |

▶ This catalog contains the typical specification only due to the limitation of space. When you consider the purchase of our products, please check our specification. For details of each product (characteristics graph, reliability information, precautions for use, and so on), see our Web site (<http://www.ty-top.com/>).

| 6. Handling | |
|--------------------------|--|
| Precautions | <ul style="list-style-type: none"> ◆ Handling <ol style="list-style-type: none"> 1. Keep the product away from all magnets and magnetic objects. ◆ Breakaway PC boards (splitting along perforations) <ol style="list-style-type: none"> 1. When splitting the PC board after mounting product, care should be taken not to give any stresses of deflection or twisting to the board. 2. Board separation should not be done manually, but by using the appropriate devices. ◆ Mechanical considerations <ol style="list-style-type: none"> 1. Please do not give the product any excessive mechanical shocks. 2. Please do not add any shock and power to a product in transportation. ◆ Pick-up pressure <ol style="list-style-type: none"> 1. Please do not push to add any pressure to a winding part. Please do not give any shock and push into a ferrite core exposure part. ◆ Packing <ol style="list-style-type: none"> 1. Please avoid accumulation of a packing box as much as possible. |
| Technical considerations | <ul style="list-style-type: none"> ◆ Handling <ol style="list-style-type: none"> 1. There is a case that a characteristic varies with magnetic influence. ◆ Breakaway PC boards (splitting along perforations) <ol style="list-style-type: none"> 1. The position of the product on PCBs shall be carefully considered to minimize the stress caused from splitting of the PCBs. ◆ Mechanical considerations <ol style="list-style-type: none"> 1. There is a case to be damaged by a mechanical shock. 2. There is a case to be broken by the handling in transportation. ◆ Pick-up pressure <ol style="list-style-type: none"> 1. Damage and a characteristic can vary with an excessive shock or stress. ◆ Packing <ol style="list-style-type: none"> 1. If packing boxes are accumulated, that could cause a deformation on packing tapes or a damage on the products. |
| 7. Storage conditions | |
| Precautions | <ul style="list-style-type: none"> ◆ Storage <ol style="list-style-type: none"> 1. To maintain the solderability of terminal electrodes and to keep the packing material in good condition, temperature and humidity in the storage area should be controlled. <ul style="list-style-type: none"> ▪ Recommended conditions <ul style="list-style-type: none"> Ambient temperature : 0~40°C Humidity : Below 70% RH ▪ The ambient temperature must be kept below 30°C. Even under ideal storage conditions, solderability of products electrodes may decrease as time passes. <ul style="list-style-type: none"> For this reason, product should be used within 6 months from the time of delivery. In case of storage over 6 months, solderability shall be checked before actual usage. |
| Technical considerations | <ul style="list-style-type: none"> ◆ Storage <ol style="list-style-type: none"> 1. Under a high temperature and humidity environment, problems such as reduced solderability caused by oxidation of terminal electrodes and deterioration of taping/packaging materials may take place. |